

Article number: 2030100M1654A2X
 Description: E+G levelling foot
 GN 30-100-M16-54-A2-X
 Note: X With female thread, Wxternal hexagon

Measures

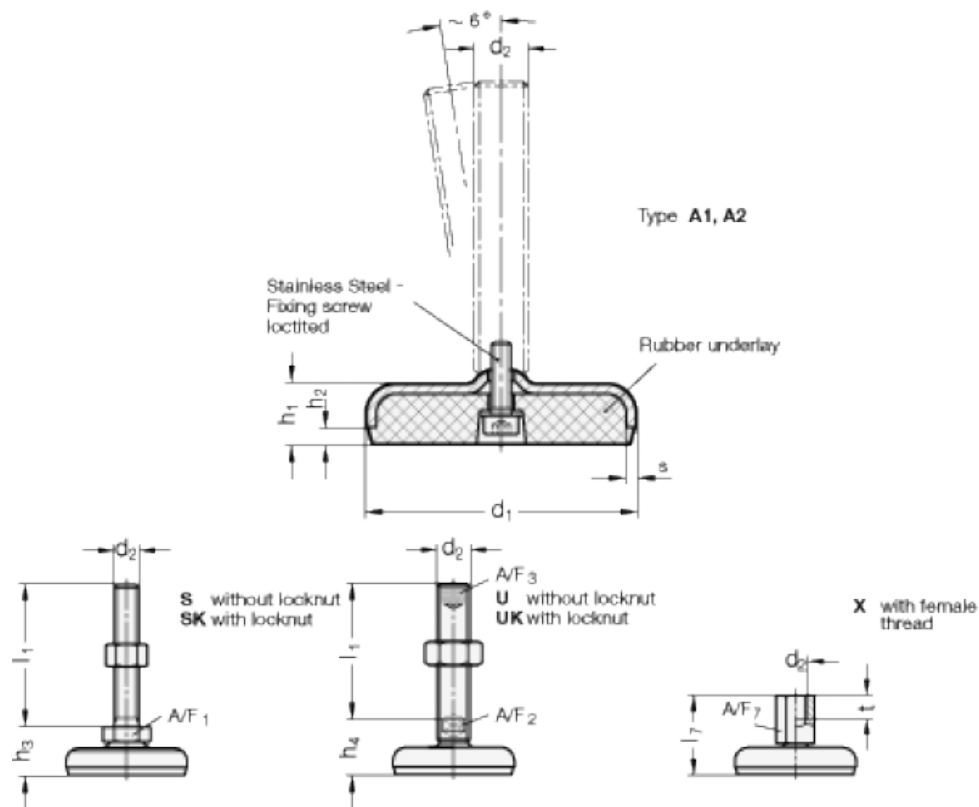

A/F7 = 22
 d1 = 100
 d2 = M16
 h1 = 22
 h2 = 6
 l7 = 54
 s = 3
 t = 16